

Installations

Select

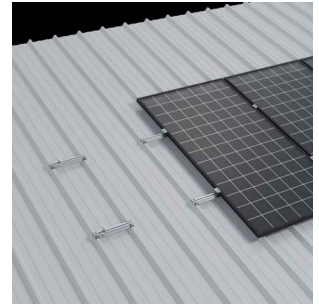

Portrait

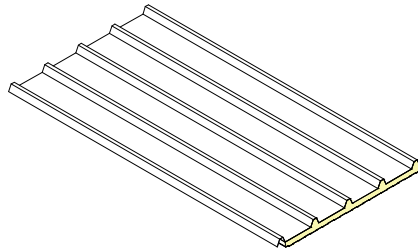
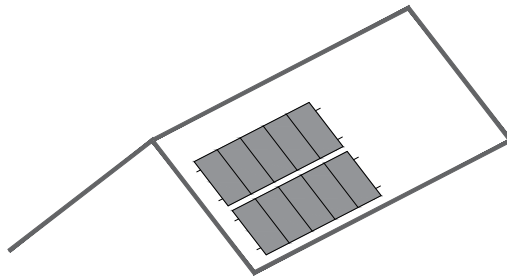

Metal Sheet

Sunfer reserves the right to make changes to the product and its associated documents at any time. The images in this document are for illustration only and may differ from the products provided.

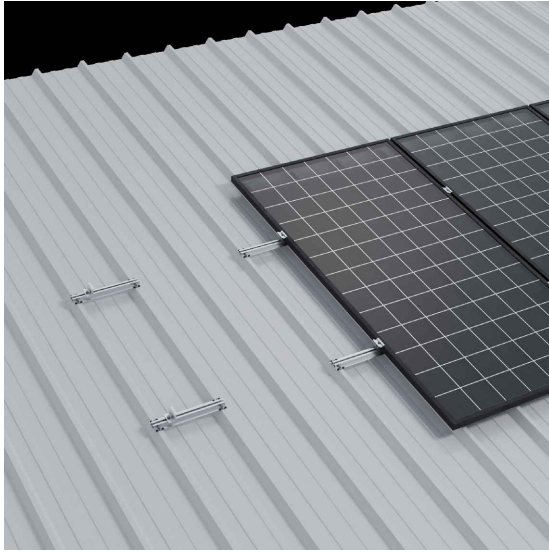

05V-BI-EN

Portrait

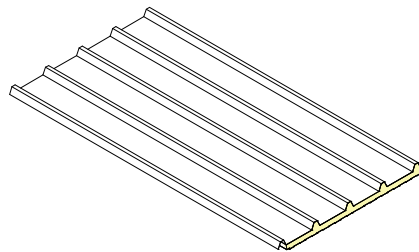
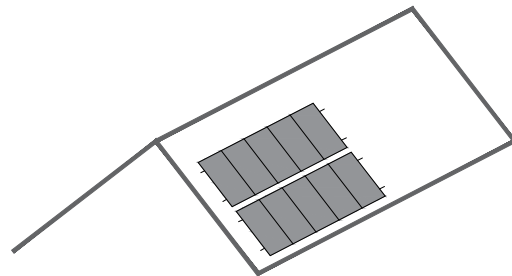

Metal Sheet



CONTENTS

- 1. General Information**
- 2. Kit Contents**
- 3. Portrait Installation**
- 4. Fastening Technical Information**
- 5. Maximum Loads and Reactions**
- 6. Installation Zone**
- 7. Installation Video**
- 8. Certificates and Guarantee**



Return







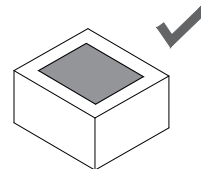
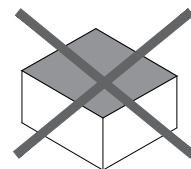
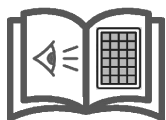
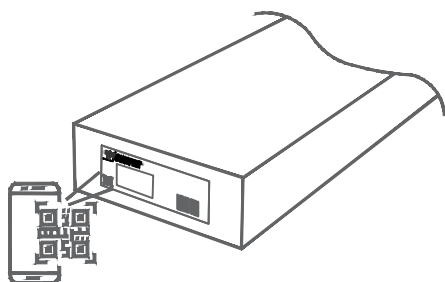



General Information and Recommendations ENG

- All installation instructions and product specifications provided must be adhered to.
- Check the condition of the roof covering and its carrying capacity. The management overseeing installation is responsible for verifying that the substructure of the roof as well as the static structure of the building itself is capable of supporting additional loads before any installation is carried out.
- To avoid turbulence from wind a minimum security distance (defined by regulations) must be maintained between the photovoltaic installations and roof edges, as well as other obstacles such as chimneys or vents.
- In the case of chimneys or other features which may need future maintenance, a minimum distance must be maintained in order to facilitate said maintenance or to extinguish fires. This distance shall be either 1m or that suggested by the relevant authority, whichever is greater.
- The surface of the roof covering must be clean and dry. Any major irregularities of the roof must be corrected or eliminated.
- The mounting must always be anchored to the structure of the roof.
- Check the weathertightness of the mount once fastened.
- Place solar panels such that they are distributed symmetrically along the support, leaving equal overhangs at each end.
- Clamps must not be tightened using impact drivers.
- Check that the support attachment points are compatible with the solar panel manufacturer's specifications.
- Uninstallation must be carried out in the reverse order from the installation.
- During the shipping of products take extreme care to maintain the integrity of the packaging. Store in a dry, well-ventilated area. Minimize exposure to large temperature differences and humidity. Avoid outdoor storage. Avoid sources of dripping water, puddles, splashing, or any other contact with water in the storage area. If the product becomes wet, immediately dry and clean as well as possible. Do not leave the product directly on the floor or ground where it may attract moisture. Store on the shipment's original pallet or on shelves.
- We reserve the right to make changes to our products at any moment without prior warning if, from our point of view, the changes are necessary for the improvement of the product. All illustrations in plans and catalogues are for example only and therefore may differ from the actual product provided.
- Aluminium components can be delivered in different finishes without compromising the structural solution. Available finishes: raw/anodised/lacquered.





	S05-BI-EN	S10-EN	S11-EN	S13
	4	4	-	2
	6	4	2	3
	8	4	4	4
	10	4	6	5
	12	4	8	6
	14	4	10	7
	16	4	12	8
	18	4	14	9

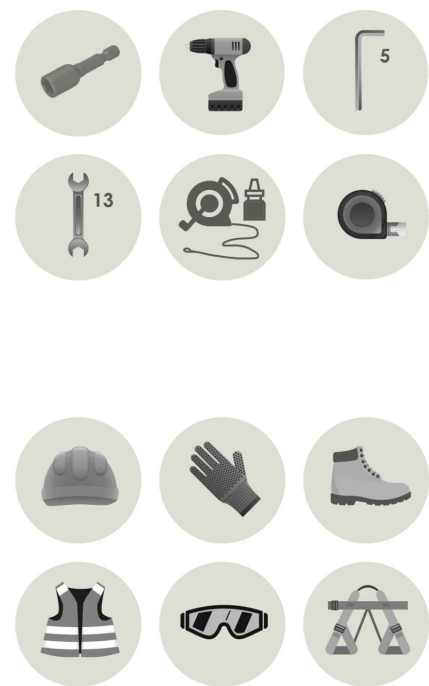

Profiles of **EN AW 6005A T6** aluminium



Fasteners of **A2-70 stainless steel**

Sheet Thickness
≥0.55 mm



≤333 mm



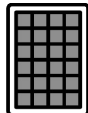

Max.
2279x1150 mm
Thickness:
28-40 mm

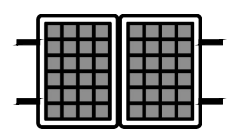

Anchoring Surfaces:

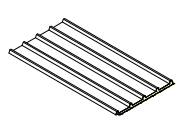

Sandwich Panel
5 Ribs

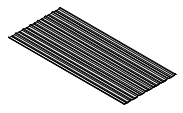

Trapezoidal Sheet

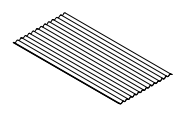

Corrugated Sheet

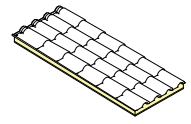

Imitation Tile Sheet



Sunfer reserves the right to make changes to the product and its associated documents at any time. The images in this document are for illustration only and may differ from the products provided.

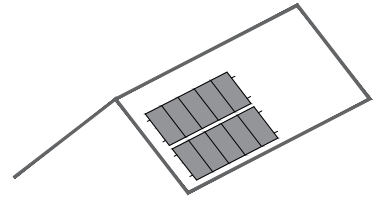

1

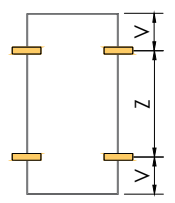

2

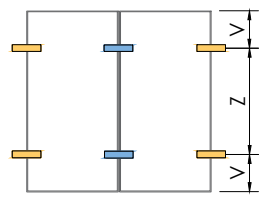

3

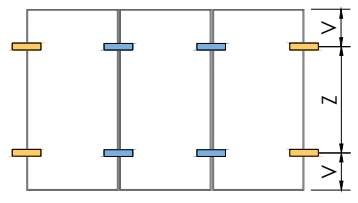

4

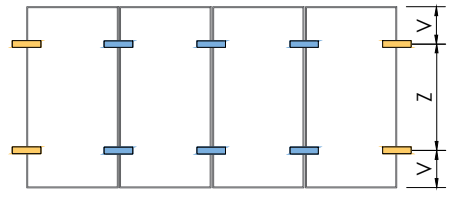

5

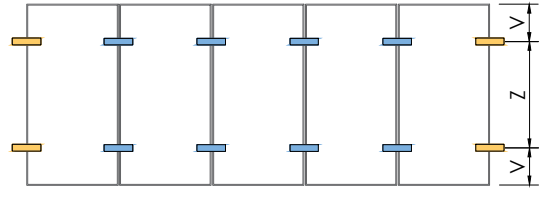

6

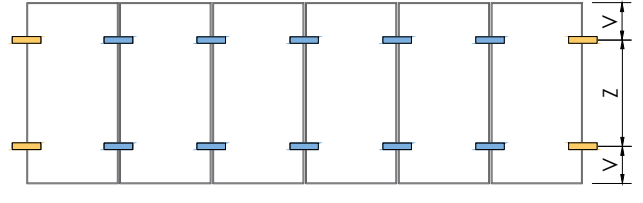

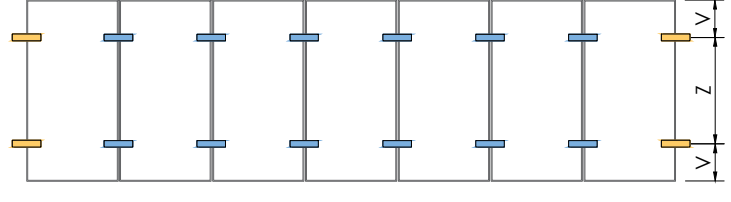

7

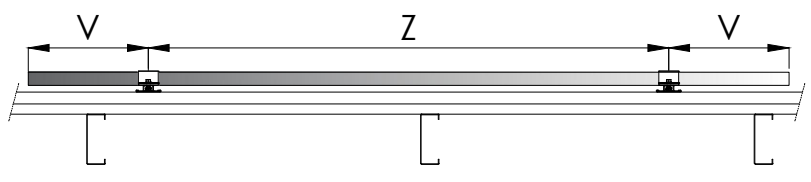
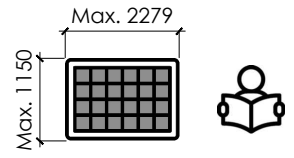
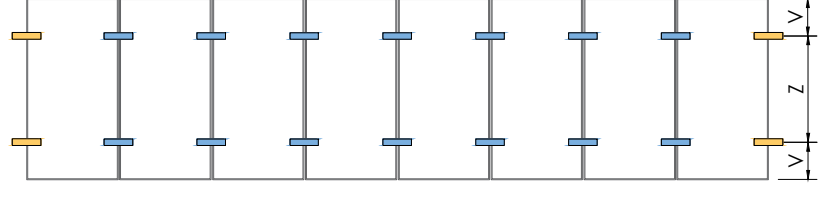

8



The maximum distance "Z" between profiles and the overhang "V" of the panel must be obtained from the technical datasheets of the panel manufacturer.

	S05-BI-EN + S10-EN
	S05-BI-EN + S11-EN

Sunfer reserves the right to make changes to the product and its associated documents at any time. The images in this document are for illustration only and may differ from the products provided.





05V-BI-EN

Structure Installation

Sunfer reserves the right to make changes to the product and its associated documents at any time. The images in this document are for illustration only and may differ from the products provided.

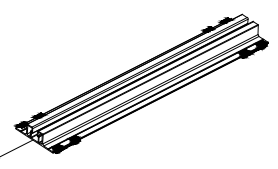
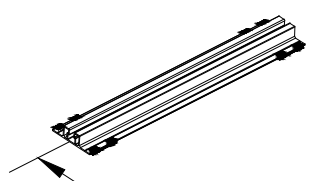
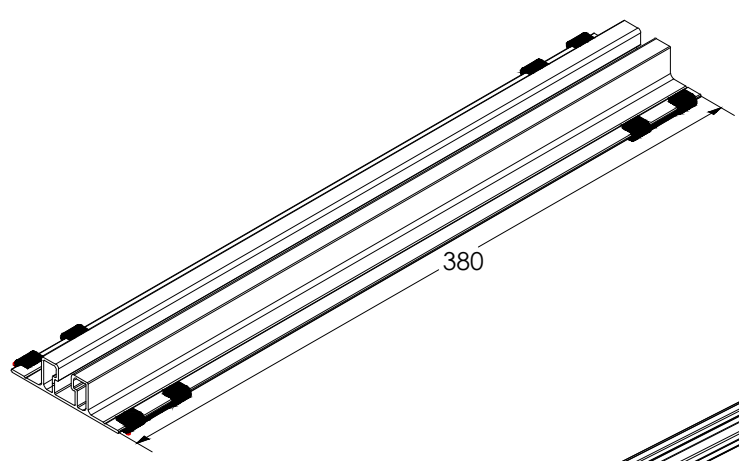
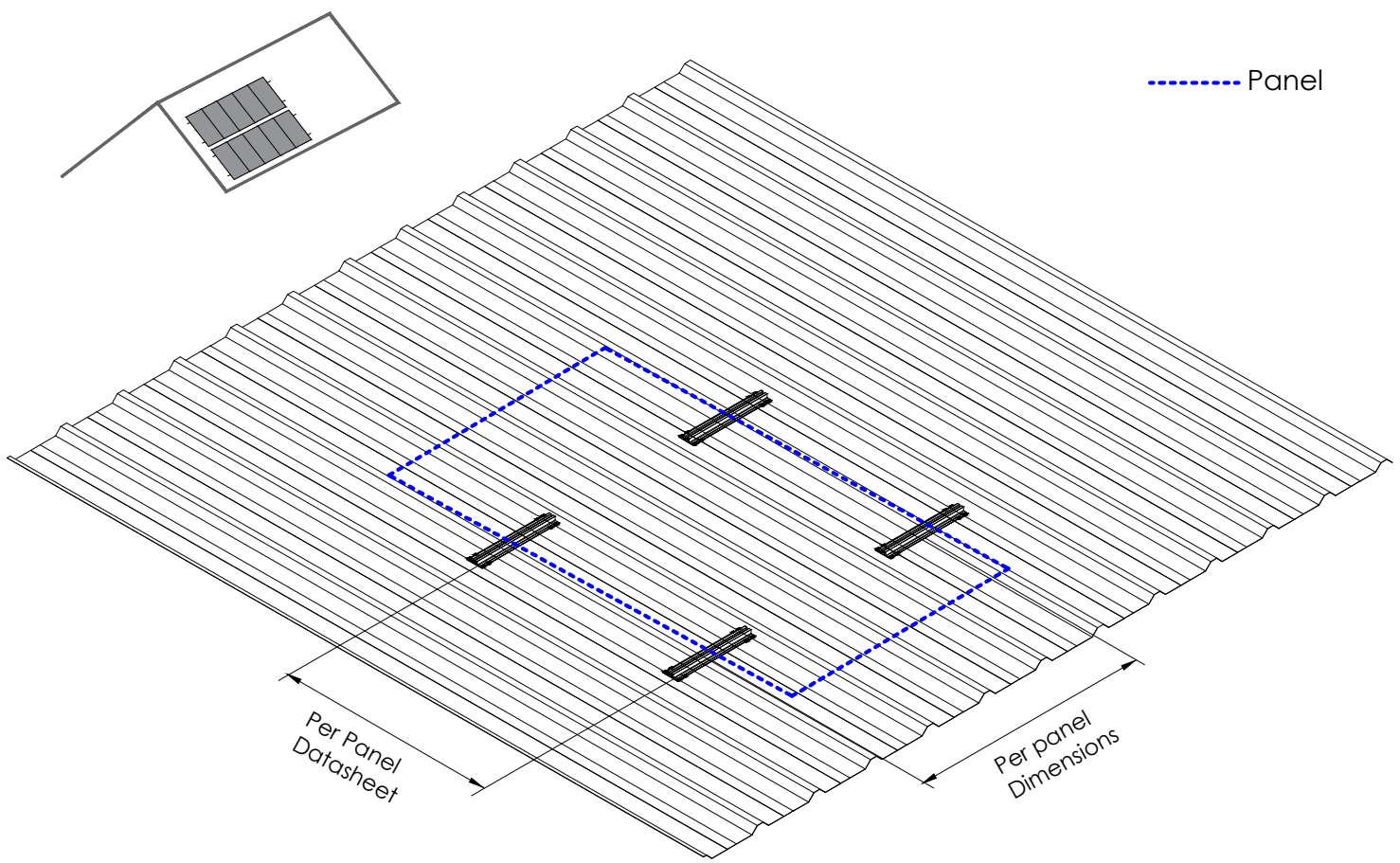

05V-BI-EN

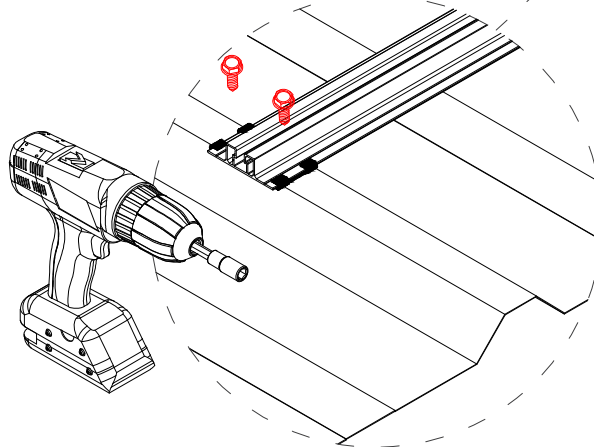
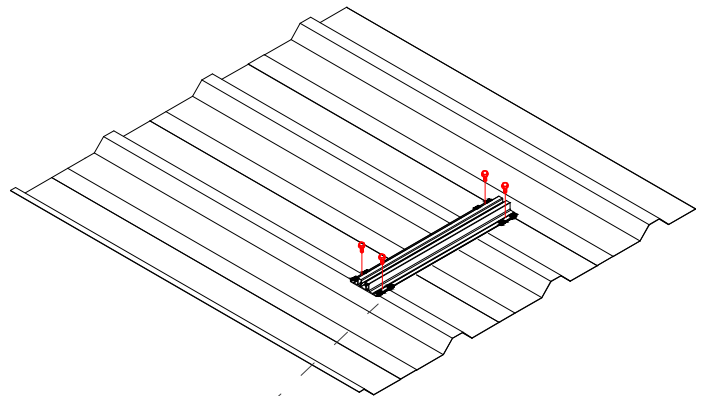
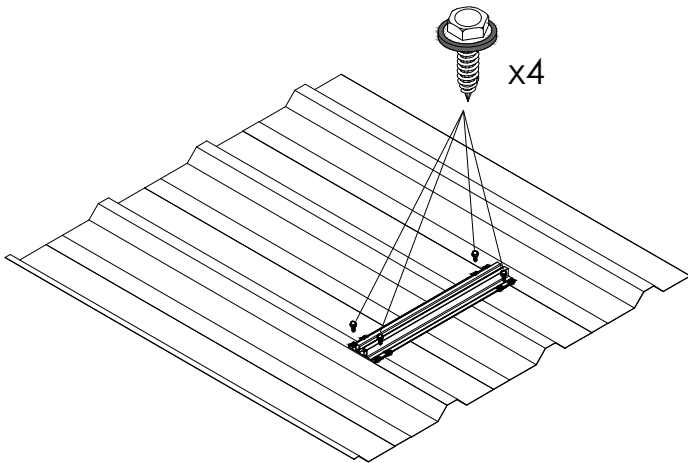
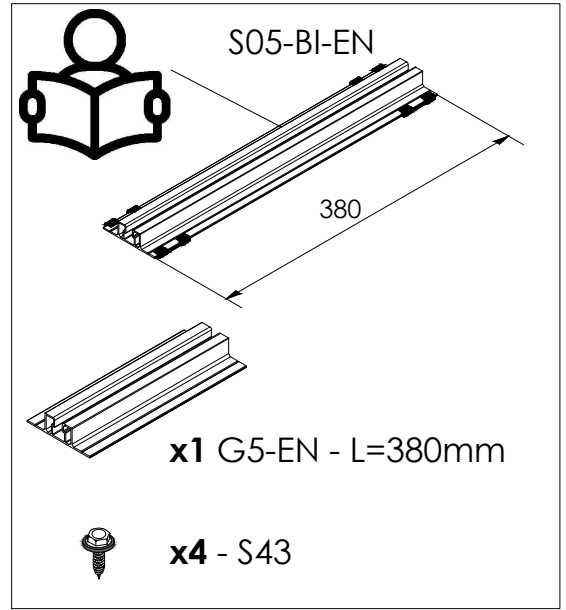
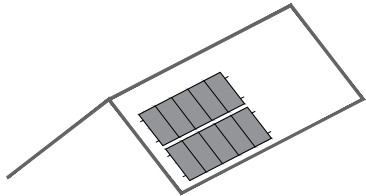

*Must support the reaction forces at the anchor point



Sunfer reserves the right to make changes to the product and its associated documents at any time. The images in this document are for illustration only and may differ from the products provided.

Sunfer reserves the right to make changes to the product and its associated documents at any time. The images in this document are for illustration only and may differ from the products provided.

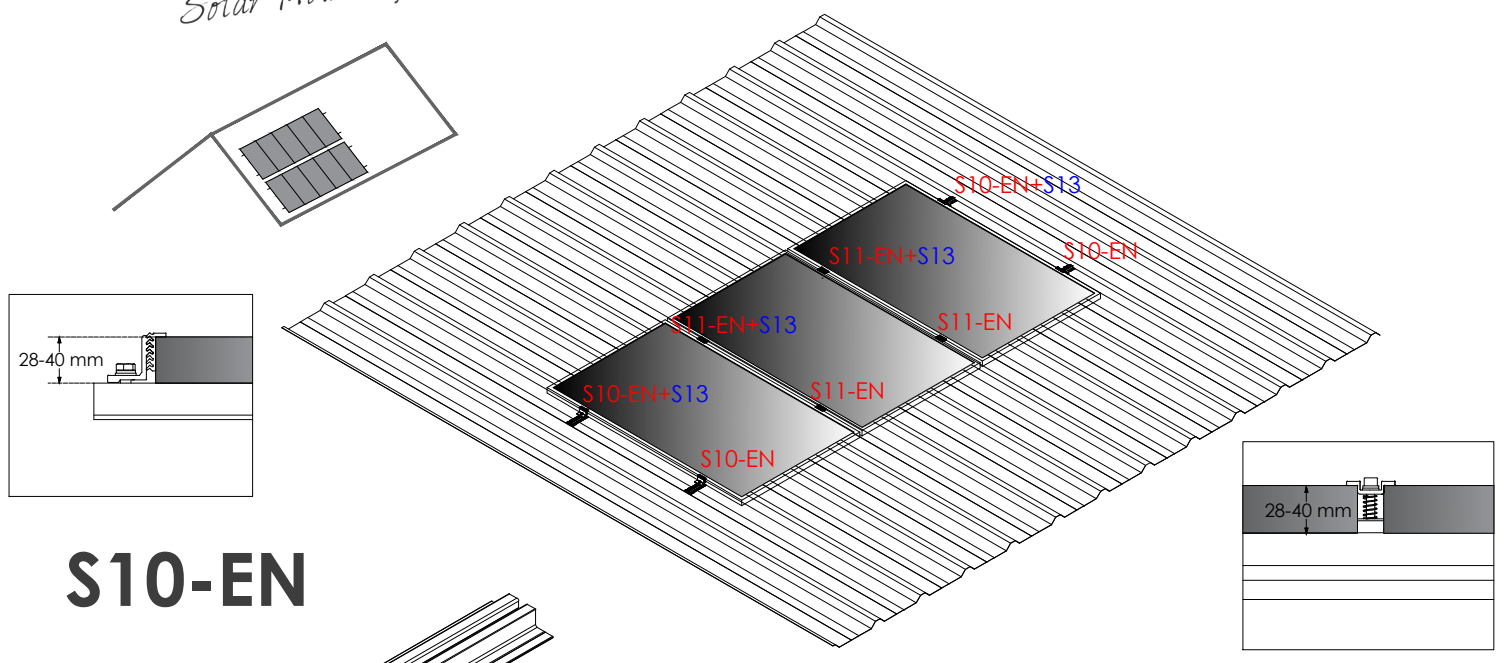

S10-EN

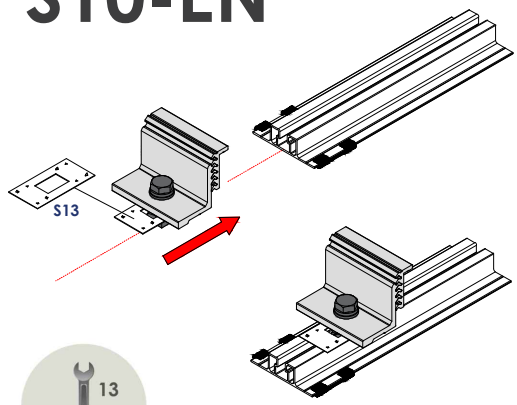

S11-EN

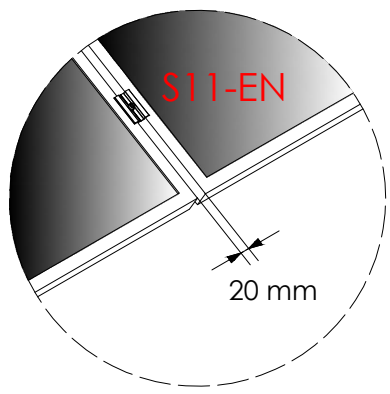
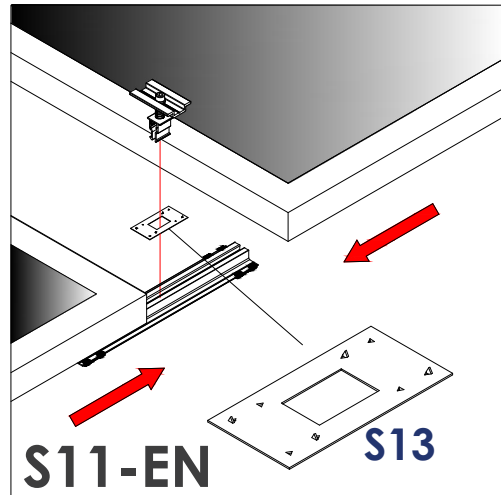
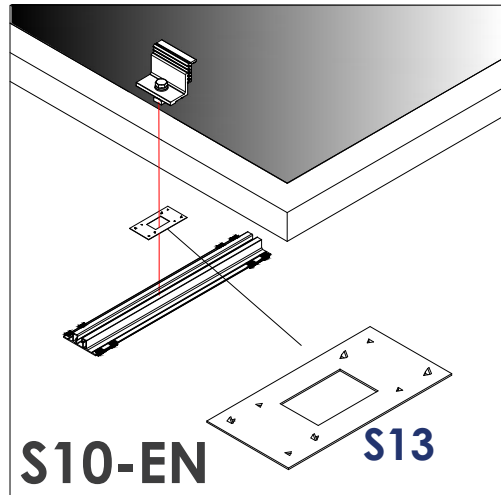
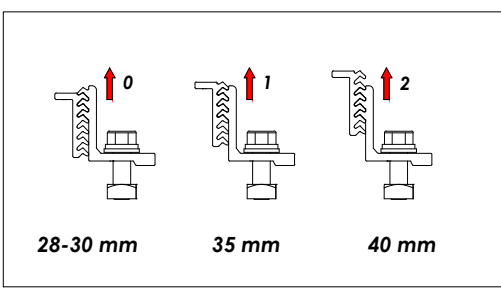
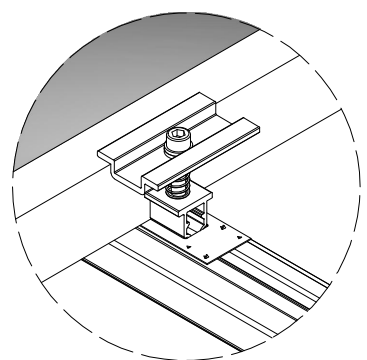
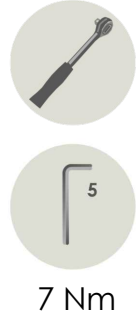
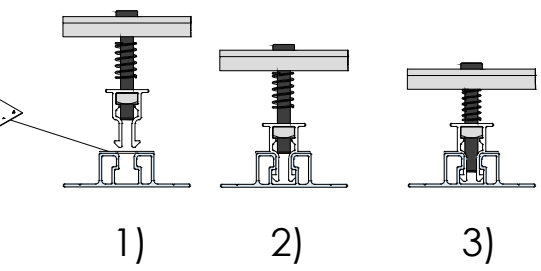
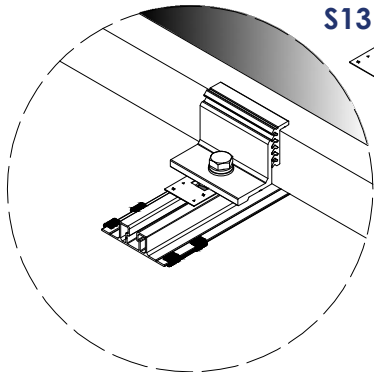

05V-BI-EN

S05-BI-EN

Technical Information: Anchors

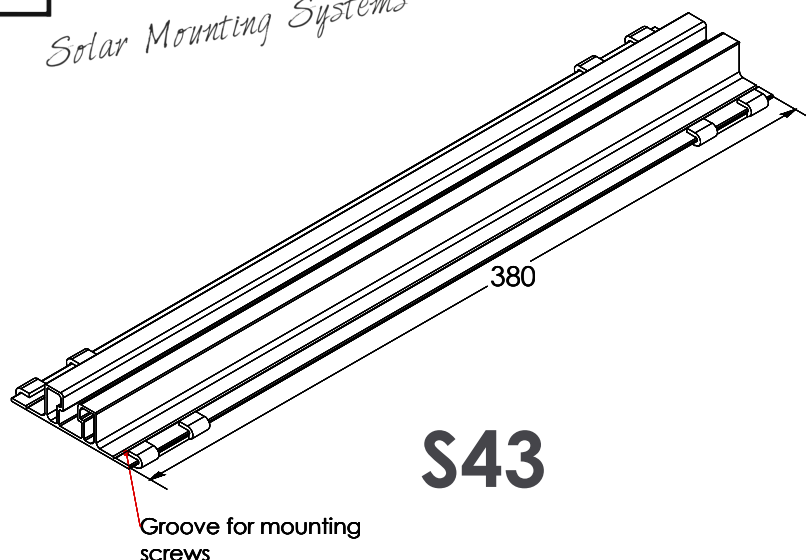

S43

Characteristics

Hex head, bimetal screw.
 A2 Stainless Steel with cemented steel tip.
 Stainless/EPDM pre-mounted sealing washer.
 Excellent adherence properties.

Technical Specifications:

Screw Length: 25 mm.
 Screw Diameter: 5,5 mm.
 SW8 Hex Head Size.
 Max Rotational Install Velocity: 1800 rpm.

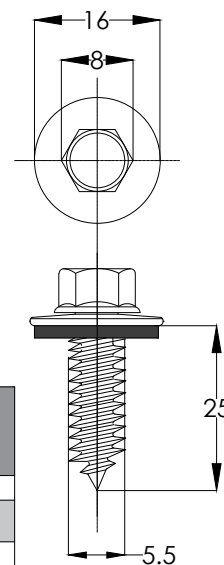

MAXIMUM SHEAR LOADS ($V_{R,k}$) AND PULLOUT LOADS ($N_{R,k}$) IN 1.5 mm ALUMINUM PROFILE + METALLIC SHEET OF A THICKNESS OF 'e'

e (mm)	0.50	0.60	0.70	0.80	0.90	1.00	1.5
$V_{R,k}$ (kN)	0.79	0.91	1.03	1.15	1.35	1.54	2.44
$N_{R,k}$ (kN)	0.46	0.60	0.75	0.89	1.04	1.18	2.12



Description	Coplanar Microrail Mount
Panel Orientation	Portrait
Format	KIT from 1 to 8 panels
Joining Kit	S15-EN not included (optional)
Application Surface	Metal Sheet
Anchoring Surface	Rib of Sheet
Type of Fastening	Screws (Screw S43)
Mount	S05-BI-EN
Profile	G5-EN
Grounding Plate	S13
Max Panel Dimensions	2279x1150 mm
Panel Thickness	from 28 to 40 mm
Materials	Fasteners: A2-70 stainless steel with case-hardened steel tip Profiles: EN AW 6005A T6 Aluminum, Raw or Anodized EPDM Weather Seal
Max Loads	Per Configuration
Structural Calculation	Computational Model Checked Against EUROCODE 9 "PROJECT STRUCTURES OF ALUMINIUM"



05V-BI-EN

Loads and Reactions

Maximum admissible loads and their reactions

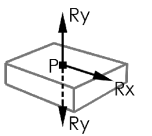
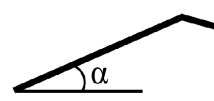

5° Pitch

10° Pitch

15° Pitch

20° Pitch

25° Pitch

30° Pitch

35° Pitch

40° Pitch

Sunfer reserves the right to make changes to the product and its associated documents at any time. The images in this document are for illustration only and may differ from the products provided.



Sunfer reserves the right to make changes to the product and its associated documents at any time. The images in this document are for illustration only and may differ from the products provided.

Maximum Admissible Loads and Reactions					5°
	Loads				
	 (Km/h)	 (Kg/m2)	(kN/mount)	(kN/mount)	(kN/mount)
1-8	110	135	0.16	0.04	1.81
	130	120	0.15	0.04	1.72
	150	110	0.13	0.00	1.54
	180	60	0.08	0.07	0.99

Table 1 - Maximum admissible loads and reactions.

Maximum Admissible Loads and Reactions					10°
	Loads				
	 (Km/h)	 (Kg/m2)	(kN/mount)	(kN/mount)	(kN/mount)
1-8	110	135	0.31	0.01	1.80
	130	120	0.29	0.03	1.74
	150	110	0.26	0.09	1.58
	180	60	0.15	0.19	1.07

Table 2 - Maximum admissible loads and reactions.

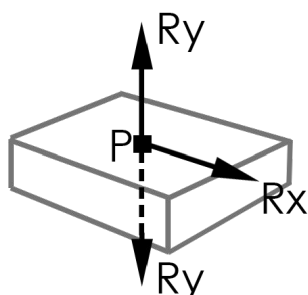

- P: Mount Point
- Rx: Shear generated at anchor
- Ry: Tension generated at anchor, compression applied to roof





Maximum Admissible Loads and Reactions					 15°
	Loads		 (kN/mount)	 (kN/mount)	 (kN/mount)
	 (Km/h)	 (Kg/m2)			
1-8	110	135	0.45	0.02	1.80
	130	120	0.42	0.11	1.76
	150	110	0.37	0.19	1.63
	180	60	0.23	0.35	1.23

Table 3 - Maximum admissible loads and reactions.



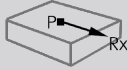
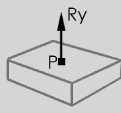
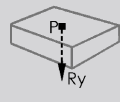

Maximum Admissible Loads and Reactions					 20°
	Loads		 (kN/mount)	 (kN/mount)	 (kN/mount)
	 (Km/h)	 (Kg/m2)			
1-8	110	135	0.58	0.02	1.69
	130	120	0.55	0.09	1.65
	150	110	0.48	0.05	1.53
	180	60	0.29	0.11	1.11

Table 4 - Maximum admissible loads and reactions.

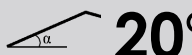

- P: Mount Point
- Rx: Shear generated at anchor
- Ry: Tension generated at anchor, compression applied to roof

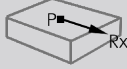
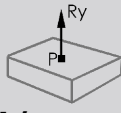
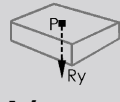

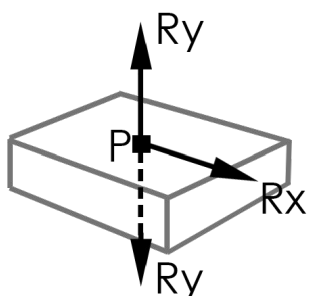

Maximum Admissible Loads and Reactions					 25°
	Loads				
	 (Km/h)	 (Kg/m2)	(kN/mount)	(kN/mount)	(kN/mount)
1-8	110	135	0.69	0.07	1.57
	130	120	0.65	0.09	1.52
	150	110	0.58	0.04	1.41
	180	60	0.35	0.07	1.00

Table 5 - Maximum admissible loads and reactions.



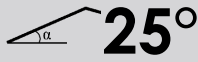

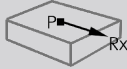
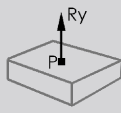
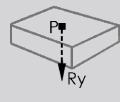
Maximum Admissible Loads and Reactions					 30°
	Loads				
	 (Km/h)	 (Kg/m2)	(kN/mount)	(kN/mount)	(kN/mount)
1-8	110	168	0.79	0.06	1.78
	130	150	0.74	0.09	1.80
	150	137	0.66	0.03	1.76
	180	75	0.40	0.07	1.80

Table 6 - Maximum admissible loads and reactions.

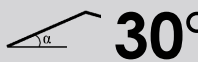

- P: Mount Point
- Rx: Shear generated at anchor
- Ry: Tension generated at anchor, compression applied to roof

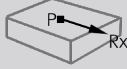
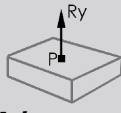
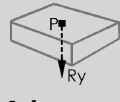
Maximum Admissible Loads and Reactions					35°
	Loads		 (kN/mount)	 (kN/mount)	 (kN/mount)
	 (Km/h)	 (Kg/m2)			
1-8	110	202	0.86	0.06	1.32
	130	180	0.81	0.08	1.28
	150	165	0.72	0.02	1.19
	180	90	0.45	0.06	0.89

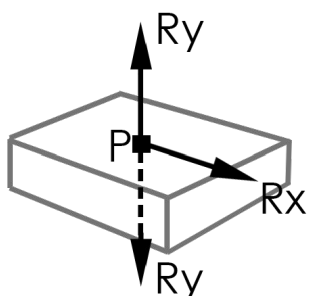
Table 7 - Maximum admissible loads and reactions.

Maximum Admissible Loads and Reactions					40°
	Loads		 (kN/mount)	 (kN/mount)	 (kN/mount)
	 (Km/h)	 (Kg/m2)			
1-8	110	253	0.91	0.06	1.17
	130	225	0.86	0.07	1.15
	150	206	0.77	0.01	1.08
	180	112	0.48	0.05	0.84

Table 8 - Maximum admissible loads and reactions.

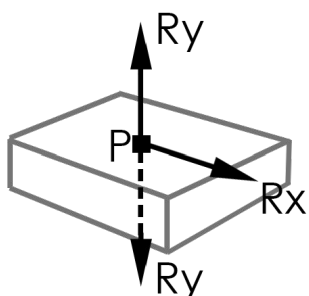

- P: Mount Point
- Rx: Shear generated at anchor
- Ry: Tension generated at anchor, compression applied to roof

Sunfer reserves the right to make changes to the product and its associated documents at any time. The images in this document are for illustration only and may differ from the products provided.

05V-BI-EN

Installation Zone

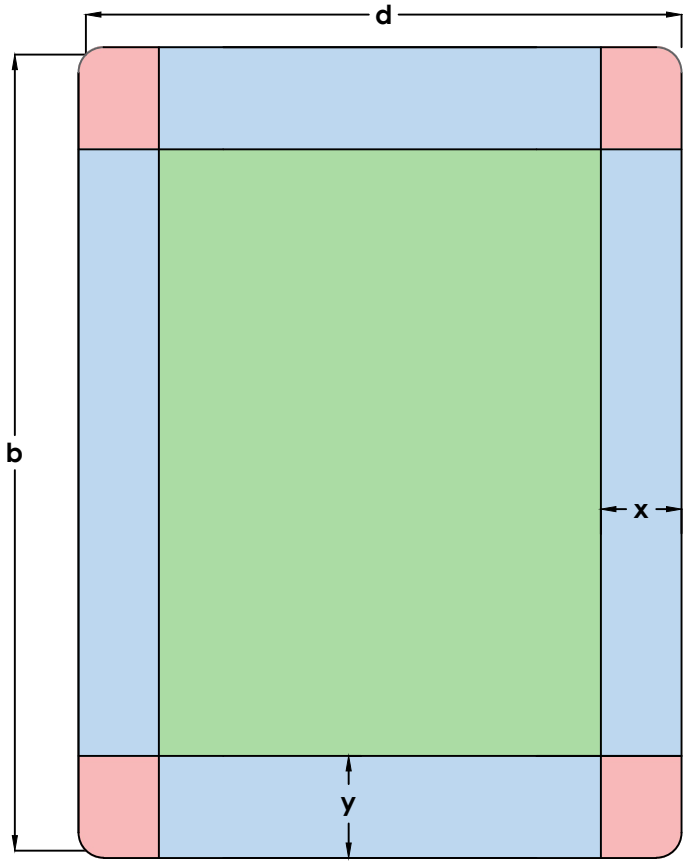



$$e = \min [b, 2h]$$

$$x = \text{Max} [e/10, 0.5\text{m}]$$

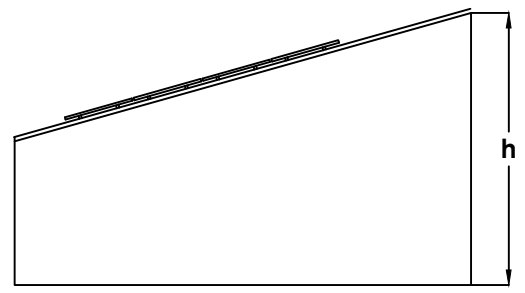
$$y = \text{Max} [e/4, 0.5\text{m}]$$



-  Installation Safe Zone
-  Turbulent Zone
-  Extremely Turbulent Zone

To avoid turbulence and other unwanted natural effects, it is strongly recommended to install photovoltaic panels inside of the green zone.

Sunfer reserves the right to make changes to the product and its associated documents at any time. The images in this document are for illustration only and may differ from the products provided.



05V-BI-EN

Installation Video

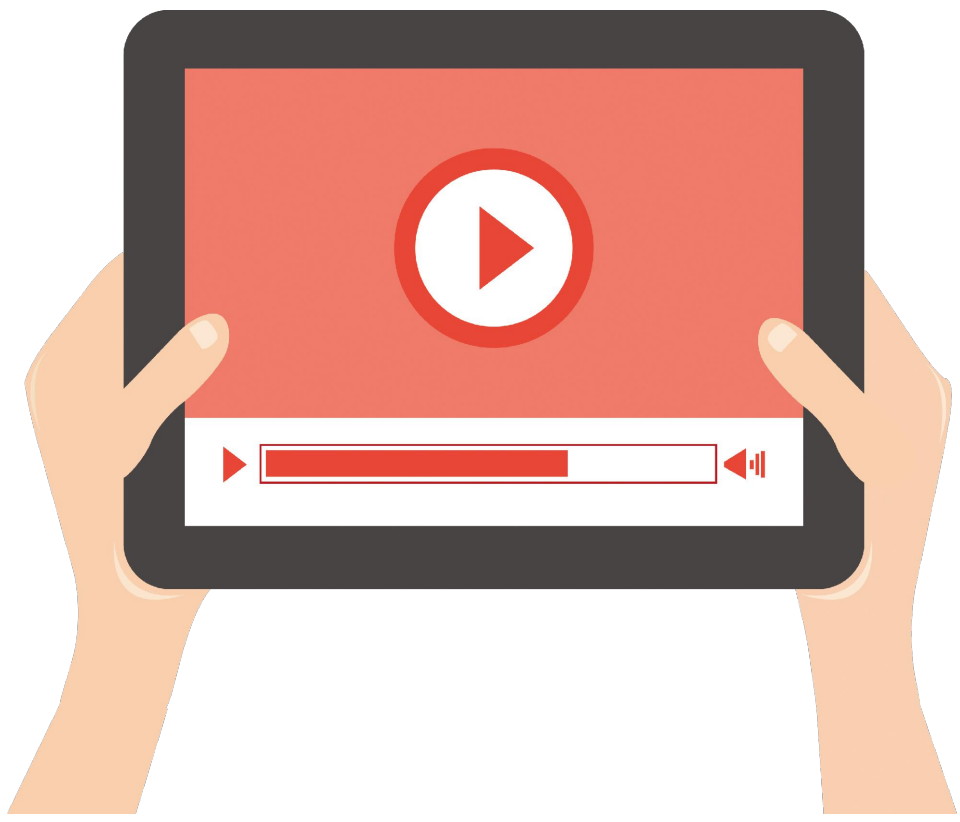

Sunfer reserves the right to make changes to the product and its associated documents at any time. The images in this document are for illustration only and may differ from the products provided.



05V-BI-EN

Certificates and Guarantee

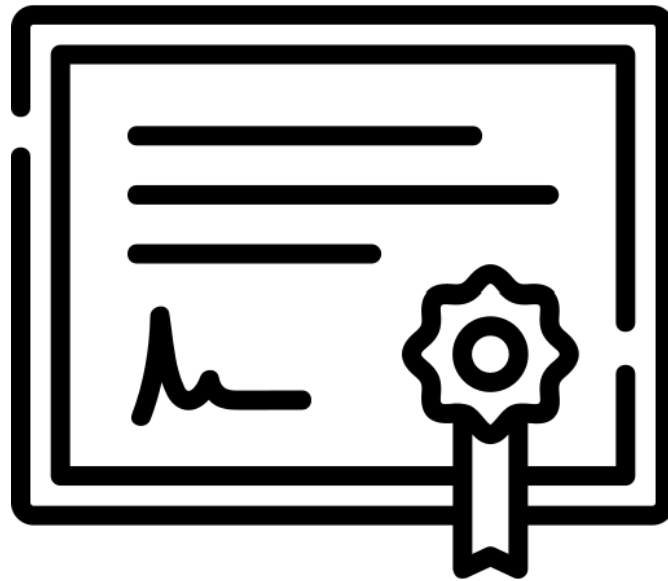

- ISO 9001 Certified
- ISO 14001 Certified
- CE Marking
- Guaranteed

This is a translation of the certificate ES13/13899

The management system of

SUNFER ESTRUCTURAS, S.L.U.

Camí de la Dula, s/n, 46687 Albalat de la Ribera, Valencia

has been assessed and certified as meeting the requirements of

ISO 9001:2015

For the following activities

Design, manufacture and sale of solar energy structures.

This certificate is valid from 19 May 2023 until 8 April 2025 and remains valid subject to satisfactory surveillance audits.

Issue 6. Certified with SGS since 8 April 2013

Last certificate expiry date 8 April 2022

Recertification audit date 31 March 2022

Authorised by _____

SGS International Certification Services Iberica, S.A.U.

C/Trespaderne, 29. 28042 Madrid. España

t +34 91 313 8115 - www.sgs.com



This document is an authentic electronic certificate for Client' business purposes use only. Printed version of the electronic certificate are permitted and will be considered as a copy. This document is issued by the Company subject to SGS General Conditions of certification services available on [Terms and Conditions](#) | [SGS](#). Attention is drawn to the limitation of liability, indemnification and jurisdictional clauses contained therein. This document is copyright protected and any unauthorized alteration, forgery or falsification of the content or appearance of this document is unlawful.



This is a translation of the certificate ES22/211172

The management system of

SUNFER ESTRUCTURAS, S.L.U.

Camí de la Dula, s/n, 46687 Albalat de la Ribera, Valencia

has been assessed and certified as meeting the requirements of

ISO 14001:2015

For the following activities

Design, manufacture and sale of solar energy structures.

This certificate is valid from 19 May 2023 until 22 April 2025 and remains valid subject to satisfactory surveillance audits.

Issue 2. Certified with SGS since 22 April 2022

Authorised by _____

SGS International Certification Services Iberica, S.A.U.

C/Trespaderne, 29. 28042 Madrid. España

t +34 91 313 8115 - www.sgs.com



This document is an authentic electronic certificate for Client' business purposes use only. Printed version of the electronic certificate are permitted and will be considered as a copy. This document is issued by the Company subject to SGS General Conditions of certification services available on [Terms and Conditions](#) | [SGS](#). Attention is drawn to the limitation of liability, indemnification and jurisdictional clauses contained therein. This document is copyright protected and any unauthorized alteration, forgery or falsification of the content or appearance of this document is unlawful.





IDENTIFICATION NUMBER OF NOTIFIED ORGANISM:

1181

NUMBER AND REGISTERED ADDRESS OF MANUFACTURERS. INSTALLATION LOCATION:

Business name: *SUNFER ESTRUCTURAS, S.L.U.*

Address: *Camí de la Dula s/n*

Postal Code: *46687*

Location: *Albalat de la Ribera*

City: *Valencia*

Country: *España*

TWO LAST DIGITS OF THE YEAR THAT THE MARKING WAS FIXED:

19

ES19/86524

EN 1090-1

Description of product:

05V-BI-EN

TOLERANCES IN GEOMETRIC INFORMATION: *EN 1090-3*

WELDABILITY: --

FRACTURE RESISTANCE: --

FIRE REACTION: *Classified material A1*

CADMIUM EMISSION: *N/A*

RADIOACTIVITY EMISSION: *N/A*

DURABILITY: *N/A*

STRUCTURAL CHARACTERISTICS:

- **Carrying capacity:** *See product instructions and data sheet*
- **Fatigue resistance:** *N/A*
- **Fire resistance:** *N/A*
- **Manufacturing:** *According to the component specification and EN1090-3. Execution class EXC1*

	DECLARATION OF PERFORMANCE	DdP
		REVISION 01

DECLARATION OF PERFORMANCE NUMBER:	P-0123
------------------------------------	--------

1. PRODUCT DESCRIPTION.

UNIQUE IDENTIFICATION CODE OF THE PRODUCT TYPE:	05V-BI-EN
---	-----------

2. NAME AND ADDRESS OF MANUFACTURER.

NAME:	SUNFER ESTRUCTURAS, S.L.U.
COMERCIAL NAME (if exists):	--
ADDRESS:	CAMI DE LA DULA S/N
CITY AND PC:	46687 ALBALAT DE LA RIBERA -- COMUNIDAD VALENCIANA (SPAIN)

3. INTENDED USE(S) OF THE PRODUCT:

ALUMINUM STRUCTURE TO SUPPORT PHOTOVOLTAIC PANELS.

4. SYSTEM OF EVALUATION AND VERIFICATION OF CONSTANCY OF PERFORMANCE:

System 2+

5. HARMONIZED STANDARD:

This product complies with the provisions of Annex ZA of the European standard **UNE-EN 1090-1:2011 + A1:2012**

6. NOTIFIED ORGANISM:

NAME:	SGS ICS IBÉRICA. S.A.
Notified Organism Number:	NB1181

7. DECLARED PERFORMANCES:

Essential Characteristics	Performances	Harmonised technical specifications
Tolerances in geometric information	Conforms to limits for essential tolerances <input type="checkbox"/>	EN 1090-3
Weldability	Not applicable because there is no welding in the structure	----
Fracture Tenacity	Not required for aluminum components	-----
Carrying Capacity	N/A	
Fatigue Resistance	N/A	
Fire Resistance	N/A	
Fire reaction	Class A1	EN 13501-1
Emission of cadmium and its compounds	OK	
Emission of radioactivity	OK	
Durability	N/A	
Structural features	See product data sheet	UNE EN 1999-1-1
- Carrying capacity	N/A	
- Fatigue resistance: N/A	N/A	
- Fire resistance: N/A	N/A	
- Manufacturing	According to the component specification. Execution class EXC1	UNE EN 1090-3

- The performance of the product identified above is in accordance with all the declared performance.
- This declaration of performance is issued in accordance with Regulation (EN) No. 305/2011 under the responsibility of the manufacturer identified above.

Manufacturer's Name: Voro Gómez Nacher

Date of issue: 02/08/2023

Signature:



Structural and Anticorrosion Guarantee

All SUNFER mounting systems are manufactured under strict production control in our factory, as are our raw materials, which are periodically tested to ensure quality. It is for these reasons we are able to offer the following guarantee for our products:

25 year Structural Guarantee

Anticorrosion Guarantee per the below table

Materials	NON-HARSH environment (1) Distance to coastline greater than 5 Km	HARSH or MARINE environment Distance to coastline less than 5 Km
Raw Aluminum	Fifteen (15) years	Five (5) years
Anodized Aluminum	Twenty-five (25) years	Twenty-five (25) years

Table 1.

(1) Non-exhaustive list of zones considered to be harsh environments:

- a. Industrial zones with emissions that include: sulphur dioxide, nitrogen oxides, sulphuric acid, sulphuric compounds, chlorine, or other volatile gases; 5 km safety distance.
- b. Electric generating stations that use the following fuels: coal, natural gas, petroleum; 5 km safety distance.
- c. Petrochemical plants; 5 km safety distance.
- d. Cellulose factories; 5 km safety distance
- e. Wastewater treatment facilities: 500 m safety distance.

In these zones it is always necessary to utilize anodized aluminum if inside of the minimum safety radius indicated above.

The warranty of the adhesive in reference 07.1H and S07.1 is ten (10) years. The warranty of the 2-sided adhesive tape of the S07.1 anchor covers the product supplied by Sunfer and can be applied provided that the breakage is caused by the tearing off of the profile with respect to the adhesive tape, in the event that the breakage is caused by the tearing off of the adhesive tape from the roofing, it will be considered a faulty assembly on site.

Mixed galvanised steel and raw aluminium supports such as, for example: Elevated, Monopoles, Car parks:
Environments C3 fifteen (15) years guarantee.
Environments C4-C5 five (5) years.

Mixed galvanised steel and anodised aluminium supports, such as: Elevated, Monopoles, Car parks:
Environments C3 guarantee twenty-five (25) years.
Environments C4-C5 fifteen (15) years.

This guarantee applies to orders supplied from 3rd January, 2023 on. Orders delivered before this date shall be governed by the guarantee that was in force at the time that the order was supplied.

The guarantee covers the final installation, and applies directly to the end user of the structure. Guarantees are managed between SUNFER and commercial distributors, so if an end user needs to invoke a guarantee, they must contact the distributor that supplied the material, and the distributor will coordinate with SUNFER Customer Service. The period of coverage of the guarantee begins upon the date that the delivery of the material is received by the end user, but will be repealed if the client does not comply with the payment terms stated in the invoice.

To invoke the guarantee, the following documentation must be produced:

- Sales invoice.
- Date system was put in service.
- Information of end user (name, address, distributor, etc).
- General photographs showing the entire system as installed.
- Installer's final work plans/drawings.
- Detailed photos of:
 - Fastening of the system to the roof, which shows the distance between mounting points.
 - The structure mounted without panels attached.
 - A rear view of the structure (from roof ridge if coplanar).





- Plan/drawing of the affected area which shows distances between mounting points.

Coverage and Exclusions

Coverage

This guarantee covers the replacement and shipping of the defective components or of the entire system if necessary, with no charge. In the case of a replacement not being available, a suitably similar replacement will be provided.

The guarantee is limited to replacement of defective products. The following costs, indirectly associated with the return process, will not be compensated: disassembly or any consequential, supplementary, or related damages, including lost profits or other indirect costs.

The guarantee covers all metallic elements included in a SUNFER structure.

Exclusions

Any issues or defects caused by or related to the following shall be excluded from the guarantee:

- Inadequate installations which did not follow the installation instructions provided by SUNFER.
- Incorrect fastener tightening torques (overtight or undertight).
- Modifications or installations other than those recommended by SUNFER.
- Installation of additional homemade or third-party elements to the structures supplied by SUNFER.
- Inadequate handling of products during the installation.
- Damage to the product after delivery, or from improper storage of the product.
- Any defect which is purely aesthetic in nature and which does not affect the structural safety of the product.
- Installations in areas whose wind and snow loads exceed those indicated in the datasheets of the product.
- Structures installed outside of the safe zone indicated in the installation manual.
- Inadequate maintenance. See the Maintenance Manual.
- Fires or exposure to temperatures above 110 °C.
- Problems or defects caused by corrosive agents not initially considered (1).
- Natural disasters such as earthquakes, hurricanes, floods, tornados, cyclones, mudslides, avalanches, or volcanic eruptions.

For structures not provided with a method of fastening to a surface, SUNFER denies responsibility in the event of collapse or failure due to insufficient fastening or poor installation.

Guarantor, Execution of guarantee

The guarantor is SUNFER ESTRUCTURAS S.L.U. located at Camino de la Dula s/n 46687, Albalat de la Ribera, Valencia, Spain.

The entitlements afforded by this guarantee are non-transferable to third parties.

Regarding the guarantee and any disputes related to it, the law currently in force in Spain shall apply.

